

1

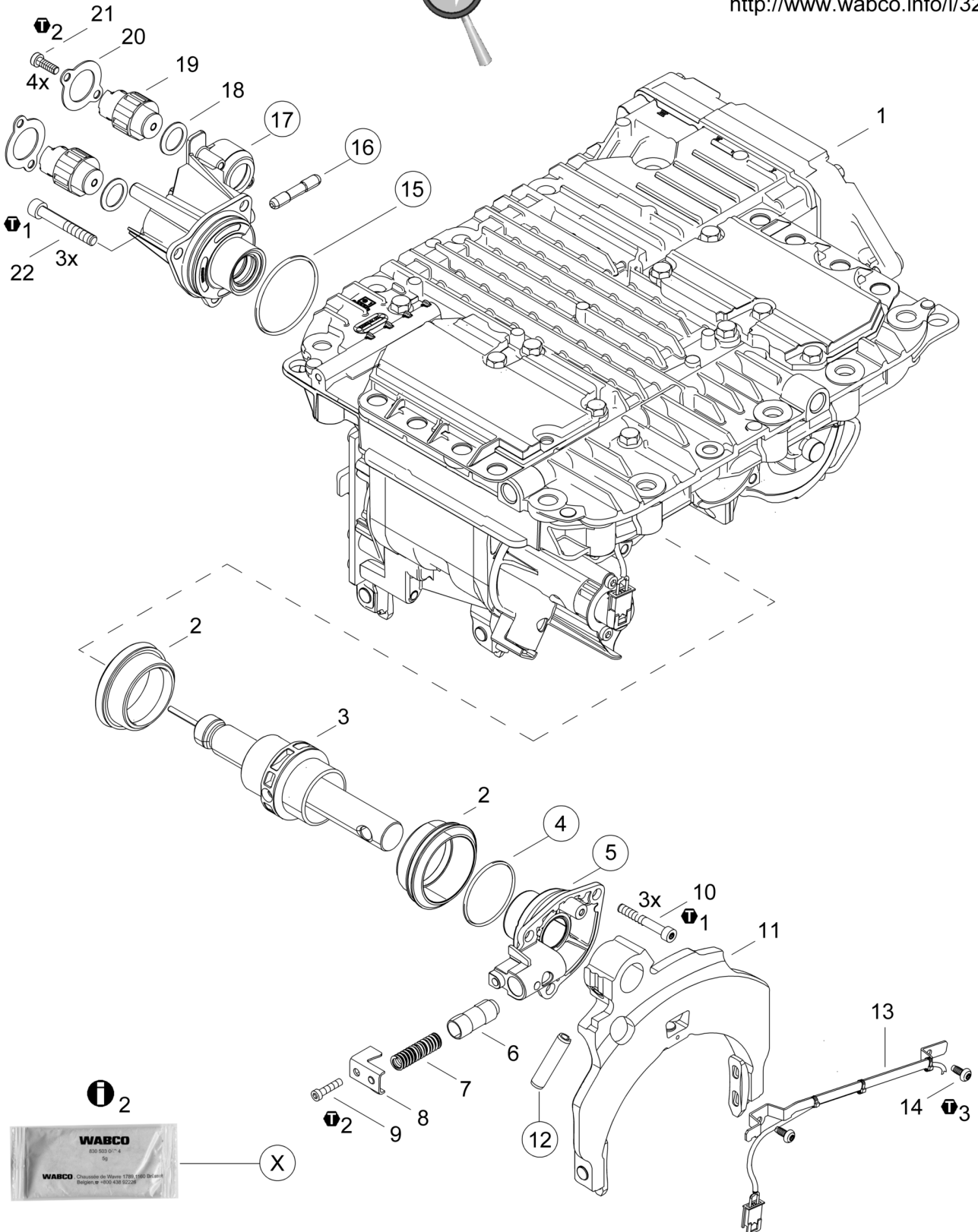





<http://www.wabco.info/i/320>



CS







Signální slova a symboly

-  **DANGER** NEBEZPEČÍ Bezprostředně hrozící nebezpečí: těžká újma na zdraví nebo smrt
-  **WARNING** POZOR Možná nebezpečná situace: jako následek lehká nebo středně těžká újma na zdraví nebo poškození majetku
-  **CAUTION** VÝSTRAHA Možná nebezpečná situace: jako následek těžká újma na zdraví nebo smrt
-  Díly, které mají číslo pozice v kroužku, jsou obsažené v opravárenské sadě.

-  Instrukce / informace ke správnému provedení opravy
-  Opravárenskou sadu je možné použít pro přístroje uvedené v tabulce.
-  Součástku utáhněte uvedeným momentem.
-  Zacházení s touto komponentou vyžaduje ochranu proti elektrostatickému výboji (ESD).





Všeobecné pokyny k opravám





1. Opravárenské práce na přístrojích systému, který má vliv na bezpečnost vozidla, smí provádět pouze kvalifikovaný personál odborné servisní dílny.
3. Dodržujte předpisy BOZP podniku a národní předpisy.
5. S opravou začněte teprve tehdy, až všechny informace nutné pro opravu přečtete a porozumíte jim. Další potřebné dokumenty: zkušební postup, list náhradních dílů, všeobecné pokyny pro opravu a kontrolu (815 150 109 3) naleznete na internetových stránkách: www.wabco-auto.com, když v databázi INFORM zadáte produktové číslo přístroje nebo číslo dokumentu.
7. WABCO nepřebírá žádnou záruku za funkci nebo kvalitu opraveného přístroje.
2. Postupujte bezpodmínečně podle pokynů a instrukcí výrobce vozidla.
4. Používejte výhradně náhradní díly od firmy WABCO nebo díly schválené výrobcem vozidla.
6. Na adekvátním zařízení přezkoušejte – podle zkušebního postupu – každý opravený přístroj na funkčnost a těsnost.

Obrázek	Symbol	Pozice	Hodnota	Poznámky
	 1	22, 10	23 ± 1,5 Nm	
	 2	9	12 ± 1,5 Nm	
	 3	14	6 ± 1 Nm	
	 1			Po opravě se často musí provést zaučení. Tento proces lze realizovat pomocí nástroje VOLVO Diagnose Tool nebo diagnostiky Diagnose W.EASY od Wabcowürth (pro vozidla s rokem výroby 2005 až 2013).
	 2	X	830 502 087 4	Namažte těsnící a kluzné plochy. GLK 112

de

Signalwörter & Symbole

-  **DANGER** GEFAHR Unmittelbar drohende Gefährdung: Schwere Personenschäden oder Tod
-  **WARNING** VORSICHT Mögliche Gefahrensituation: Leichte oder mittelschwere Personenschäden oder Sachschäden als Folge
-  **CAUTION** WARNUNG Mögliche Gefahrensituation: Tod oder schwere Personenschäden als Folge
-  Teile mit Kreis um die Positionsnummer sind im Reparatursatz enthalten.

-  Anweisung / Information für eine korrekte Reparatur
-  Der Reparatursatz kann für Geräte entsprechend Tabelle verwendet werden.
-  Element mit angegebenen Drehmoment anziehen.
-  Die Handhabung dieser Komponente erfordert einen Schutz gegen Elektrostatische Entladung (ESD).

de

Allgemeine Reparaturhinweise

1. Reparaturarbeiten an Geräten eines Fahrzeug-Sicherheitssystems darf nur qualifiziertes Personal einer Fachwerkstatt durchführen.
2. Leisten Sie den Vorgaben und Anweisungen des Fahrzeugherstellers unbedingt Folge.
3. Halten Sie Unfallverhütungsvorschriften des Betriebes sowie nationale Vorschriften ein.
4. Verwenden Sie ausschließlich von WABCO oder vom Fahrzeughersteller freigegebene Ersatzteile.
5. Beginnen Sie die Reparatur erst dann, wenn Sie alle Informationen, die für die Reparatur notwendig sind, gelesen und verstanden haben. Zusätzlich benötigte Dokumente: Prüfanweisung, Ersatzteilblatt, Allgemeine Reparatur- und Prüfhinweise (815 020 109 3) zu finden auf www.wabco-auto.com mittels Eingabe der Produktnummer des Gerätes bzw. Druckschriftennummer in INFORM.
6. Prüfen Sie jedes reparierte Gerät – gemäß Prüfanweisung – an einer adäquaten Einrichtung auf Funktionstüchtigkeit und Dichtigkeit.
7. WABCO übernimmt keinerlei Gewährleistung für die Funktion oder Qualität eines reparierten Gerätes

Bild	Symbol	Position	Wert	Bemerkungen
	1	22, 10	23 ± 1,5 Nm	
	2	9	12 ± 1,5 Nm	
	3	14	6 ± 1 Nm	
	1			Nach der Reparatur kann ein Einlernvorgang erforderlich sein. Dieser Vorgang kann mit dem VOLVO Diagnose Tool oder der Wabcowürth Diagnose W.EASY (für Fahrzeug Baujahr 2005 bis 2013) durchgeführt werden.
	2	X	830 502 087 4	Fetten Sie die Dicht- und Gleitflächen ein. GLK 112

en

Symbols & Signal Words

- DANGER** Imminent hazard situation: serious personal injury or death as a result
- WARNING** Possible hazard situation: minor or moderate personal injury or material loss as a result
- CAUTION** Possible hazard situation: serious personal injury or death as a result
- Parts having item numbers with circles are included in the kit.
- Instruction / Information for a correct repair
- The kit can be used for devices according table.
- Fasteners must be tightened to a specific torque.
- Handling of this component requires protection against electro static discharge (ESD)





General Repair Hints





1. Only qualified personnel of a specialist workshop are authorized to perform repair work on a vehicle's security system.
2. Absolutely follow specifications and instructions of vehicle manufacturer.
3. Keep to company's relevant accident prevention regulations and national regulations.
4. Use only spare parts released by WABCO or vehicle manufacturer.
5. Always start repair work only when you have read and understood all information required for repair. Documents additionally needed: Test Instruction, Spare Parts List, General Repair and Test Hints (815 010 109 3) to be found on www.wabco-auto.com by entering product number of the device or the publication number in INFORM.
6. Check each repaired equipment for functional efficiency and tightness on an adequate facility according to the test instruction.
7. WABCO does not accept any liability or responsibility for the quality or functionality of a repaired device

Picture	Symbol	Item	Value	Comments
	1	22, 10	23 ± 1,5 Nm	
	2	9	12 ± 1,5 Nm	
	3	14	6 ± 1 Nm	
	1			A learning procedure may be required following a repair. This procedure can be carried out with the VOLVO diagnostic tool or the W.EASY diagnosis from Wabcowürth (for vehicles with year of construction 2005 to 2013).
	2	X	830 502 087 4	Lubricate sealing and sliding surfaces. GLK 112

es







Símbolos & Palabras de aviso

-  **DANGER** PELIGRO Situación de peligro inminente: Pueden ocasionarse daños personales graves o incluso mortales
-  **WARNING** CUIDADO Posible situación de peligro: Pueden ocasionarse daños personales leves o moderados o pérdidas materiales
-  **CAUTION** ADVERTENCIA Posible situación de peligro: Pueden ocasionarse daños personales graves o incluso mortales
-  Los componentes incluidos en el kit son los números que aparecen con círculo.

-  Instrucciones/Información para una correcta reparación
-  El kit puede ser utilizado en los equipos que aparecen en la tabla.
-  Los cierres deben apretarse con un par de apriete determinado.
-  La manipulación de este componente requiere protección contra descargas electrostáticas (ESD)





Consejos generales de reparación





1. Sólo el personal cualificado de un taller especializado está autorizado para realizar las tareas de reparación en los sistemas de seguridad de los vehículos.
 3. Siga las regulaciones y normas acerca de prevención de riesgos laborales de su empresa y de su país.
 5. Comience la reparación sólo cuando haya leído y comprendido las instrucciones de reparación. Documentos adicionales necesarios: Instrucciones de comprobación, listas de despiece, consejos generales de comprobación y reparación (815 040 109 3), los cuales pueden encontrarse en www.wabco-auto.com, introduciendo la referencia del aparato o la referencia de la publicación en la aplicación INFORM.
 7. WABCO no asume garantía alguna por el funcionamiento o calidad de un equipo reparado.
2. Atenerse exactamente a las indicaciones e instrucciones del fabricante del vehículo.
 4. Utilice piezas de repuesto suministradas por WABCO o el fabricante del vehículo.
 6. Compruebe la eficacia de funcionamiento y de ajuste de cada equipo reparado en unas instalaciones adecuadas según las instrucciones de comprobación.

Dibujo	Símbolo	Posición	Valor	Observaciones
	 1	22, 10	23 ± 1,5 Nm	
	 2	9	12 ± 1,5 Nm	
	 3	14	6 ± 1 Nm	
	 1			Después de la reparación puede ser necesario efectuar un proceso de aprendizaje. Este proceso puede efectuarse con la herramienta de diagnóstico VOLVO o con la herramienta de diagnóstico W.EASY de Wabcowürth (para vehículos construidos entre 2005 y 2013).
	 2	X	830 502 087 4	Las juntas y las superficies deslizantes deben lubricarse. GLK 112

fr

Symboles & Significations





-  **DANGER** DANGER Situation de danger imminent : Danger de mort ou de dommage corporel sérieux.
-  **WARNING** ATTENTION Situation de danger probable : Risque de dommage corporel mineur ou modéré ou perte de matériel.
-  **CAUTION** AVERTISSEMENT Situation de danger de danger probable : Danger de mort ou de dommages corporel sérieux
-  Les composants avec repères entourés sont inclus dans le kit.

-  Instruction/Information pour une réparation correcte
-  Le kit peut être utilisé pour les appareils indiqués sur le Feuille.
-  Les fixations doivent être serrées à un couple spécifique.
-  La manipulation de cette composante nécessite une protection contre les décharges électro statiques (ESD)

fr





Conseils généraux de réparation





1. Uniquement le personnel qualifié d'un atelier agréé WABCO est autorisé à effectuer la réparation sur les systèmes de sécurité d'un véhicule.
2. Respecter toujours les prescriptions et instructions du constructeur du véhicule.
3. Veillez aux règlements de prévention des accidents indiqués par votre société et aux règlements nationaux.
4. Employez seulement les pièces de rechange WABCO ou du constructeur du véhicule.
5. Commencez toujours le travail de réparation seulement après avoir lu et compris toutes les informations indiquées pour la réparation. Documentation complémentaire nécessaire : Instruction d'essai, liste des pièces détachées, instructions de réparation et conseils d'essai (815 030 109 3) en tapant la référence du produit ou le numéro de la publication dans INFORM sur internet : www.wabco-auto.com
6. Examinez chaque appareil réparé pour s'assurer de l'efficacité fonctionnelle et de l'étanchéité selon l'instruction d'essai.
7. WABCO n'assume aucune garantie quant au fonctionnement ou à la qualité d'un appareil réparé.

Image	Symbole	Position	Valeur	Remarques
	1	22, 10	23 ± 1,5 Nm	
	2	9	12 ± 1,5 Nm	
	3	14	6 ± 1 Nm	
	1			Après la réparation, il se peut qu'un apprentissage soit nécessaire. Cette procédure peut s'effectuer avec l'outil de diagnostic de VOLVO ou avec Diagnose W.EASY de Wabcowürth (pour les véhicules dont l'année de construction est comprise entre 2005 et 2013).
	2	X	830 502 087 4	Les surfaces d'étanchéité et de frottement doivent être graissées. GLK 112

hr

Simboli & Značenja





-  **DANGER** OPREZ Neposredna rizična situacija: moguće ozbiljno ozljeđivanje ili smrt
-  **WARNING** OPASNOST neposredna rizična situacija: moguće manje ozljeđivanje materijalna šteta
-  **CAUTION** UPOZORENJE Neposredna rizična situacija: moguće ozbiljno ozljeđivanje ili smrt
-  Dijelovi uređaja čiji su brojevi zaokruženi nalaze se u kompletu..

-  Informacija o ispravnom popravku.
-  Set može biti korišten za uređaje prema tabeli.
-  Spone moraju biti stegnute prema specifičnim silama zatezanja.
-  Rukovanje ovim uređajem zahtjeva zaštitu od elektro statičkog pražnjenja

Opće upute o popravcima





1. Samo kvalificirane osobe istručnjaci smiju popravljati sigurnosne sustave na vozilu.
2. U potpunosti slijedi specifikacije i upute proizvođača vozila.
3. Provodi tvrtkine sigurnosne propise kao i nacionalne propise o sigurnosti
4. Koristi rezervne dijelove proizvedene od WABCO ili proizvođača vozila..
5. Popravak počni tek nakon što pročitaš i shvatiš upute o popravku. Potrebni dokumenti: Instrukcije o testiranju, Lista rezervnih dijelova, Opće natuknice o popravku i testiranju (815 010 109 3) mogu se naći na www.wabco-auto.com nakon upisa kataloškog broja proizvoda ili publikacije u INFORM-u.
6. Provjeri svaki popravljeni uređaj kako radi i da li je zategnuto sve kako treba prema odgovarajućim uputama o testiranju proizvoda.
7. WABCO ne preuzima odgovornost za rad i kvalitetu popravljenog uređaja.





hr

Slika	Simbol	Pojedinost	Vrijednost	Komentar
1	 1	22, 10	23 ± 1,5 Nm	
	 2	9	12 ± 1,5 Nm	
	 3	14	6 ± 1 Nm	
	 1			Nakon popravka možda će trebati postupak učenja. Taj postupak možete obaviti alatom VOLVO Diagnose Tool ili Wabcowürth Diagnose W.EASY (za model vozila od 2005. do 2013.).
	 2	X	830 502 087 4	Brtvene i klizne površine treba podmazati. GLK 112

it





Simboli e Segnali

-  **DANGER** PERICOLO Imminente situazione di rischio: serie ferite personali fino anche alle morte
-  **WARNING** PRUDENZA Possibili situazioni di pericolo: possibili lievi ferite o perdita di materiale
-  **CAUTION** AVVERTENZA Possibili situazioni di pericolo: serie ferite personali fino anche alle morte
-  I componenti indicati con un numero cerchiato, sono inclusi nel kit.

-  Istruzioni/Informazioni per un'accurata riparazione
-  Il kit può essere usato per gli articoli secondo la tabella.
-  I fissaggi devono essere stretti ad una coppia di serraggio specifica.
-  L'impiego di questi componenti richiede una protezione da scariche elettrostatiche (ESD).



Suggerimenti per la riparazione



1. Soltanto il personale qualificato delle officine specializzate è autorizzato ad effettuare le riparazioni sui sistemi di sicurezza dei veicoli.
3. Attenersi alle norme nazionali e aziendali in merito alla prevenzione degli infortuni.
5. Effettuare la riparazione solamente dopo aver letto e capito tutte le informazioni richieste per la riparazione. Ulteriori informazioni necessarie: istruzioni di collaudo, catalogo dei ricambi, cenni generali sulla riparazione e test (815 050 109 3) possono essere trovati sul sito www.wabco-auto.com alla voce INFORM entrando per codice dell'apparecchio o per numero della pubblicazione.
7. WABCO non si assume alcuna responsabilità per il funzionamento o la qualità di un apparecchio riparato.
2. E' assolutamente necessario seguire le istruzioni e le specifiche del costruttore del veicolo.
4. Usare solo ricambi originali WABCO o del costruttore del veicolo.
6. Controllare la funzionalità e l'efficienza di ogni apparecchiatura riparata secondo le istruzioni riportate nel manuale di collaudo.

Figura	Simbolo	Particolare	Valore	Note
1	 1	22, 10	23 ± 1,5 Nm	
	 2	9	12 ± 1,5 Nm	
	 3	14	6 ± 1 Nm	
	 1			Dopo la riparazione potrebbe essere necessario un processo di apprendimento. Questo processo può essere eseguito con lo strumento di diagnosi VOLVO o con lo strumento di diagnosi W.EASY Wabcowürth (per veicoli di modelli dal 2005 al 2013).
	 2	X	830 502 087 4	Superfici di tenuta e di scorrimento devono essere lubrificate. GLK 112

pl

Hasła ostrzegawcze i symbole







-  **DANGER** NIEBEZPIECZEŃSTWO Bezpośrednie zagrożenie ciężkimi obrażeniami bądź śmiercią.
-  **WARNING** UWAGA! Niebezpieczeństwo grożące lekkimi bądź średnimi obrażeniami.
-  **CAUTION** OSTRZEŻENIE Niebezpieczeństwo grożące śmiercią bądź ciężkimi obrażeniami.

-  Wskazówki / Informacje dotyczące poprawnej naprawy.
-  Zestaw naprawczy może być używany do urządzeń według tabeli.
-  Dokręcić element podanym momentem obrotowym.

pl







Ogólne porady naprawcze

1. Prace naprawcze w obrębie urządzeń układu bezpieczeństwa pojazdu mogą być wykonane jedynie przez wykwalifikowany personel specjalistycznego warsztatu.
3. Należy przestrzegać zakładowych i krajowych przepisów BHP.
5. Naprawę należy rozpocząć dopiero wówczas, gdy wszystkie potrzebne do niej informacje zostaną przeczytane i zrozumiane. Dokumenty potrzebne dodatkowo: instrukcja kontrolna, tabela części zamiennych, ogólne wskazówki dotyczące naprawy i kontroli (815 020 109 3) znajdują Państwo na stronie internetowej www.wabco-auto.com, podając numer urządzenia bądź numer publikacji w bazie INFORM.
7. WABCO nie udziela żadnej gwarancji na działanie lub jakość naprawionego urządzenia.
2. Należy koniecznie postępować według wytycznych i wskazówek producenta pojazdu.
4. Należy używać wyłącznie części zamiennych dopuszczonych przez firmę WABCO bądź przez producenta pojazdu.
6. Na odpowiednim urządzeniu należy sprawdzić każde naprawiane urządzenie - zgodnie z instrukcją kontrolną - pod kątem sprawności działania i szczelności.

Obraz	Symbol	Pozycja	Wartość	Komentarz
	 1	22, 10	23 ± 1,5 Nm	
	 2	9	12 ± 1,5 Nm	
	 3	14	6 ± 1 Nm	
	 1			Po dokonaniu naprawy konieczny może być proces programowania adaptacyjnego. Tę operację można przeprowadzić za pomocą narzędzia diagnostycznego VOLVO lub diagnozy Wabcowürth W.EASY (dla pojazdów wyprodukowanych między 2005 i 2013 rokiem).
	 2	X	830 502 087 4	Należy nasmarować powierzchnie uszczelniające i ślizgowe. GLK 112

ru

Знаки & символы

-  **DANGER** ОПАСНО Прямая угроза аварийной ситуации: влечет за собой смерть или тяжелые повреждения
-  **WARNING** ОСТОРОЖНО Опасная ситуация: последствиями являются легкие повреждения или повреждения средней тяжести, а также материальный ущерб
-  **CAUTION** ПРЕДУПРЕЖДЕНИЕ Опасная ситуация: влечет за собой смерть или тяжелые повреждения
-  Номера частей, обведенные кружком, Вы найдете в ремкомплекте.
-  Указание/информация для проведения надлежащего ремонта
-  Ремкомплект может быть использован для приборов соответственно таблице.
-  Элемент необходимо подтянуть с помощью заданного момента сопротивления.
-  При обращении с данным устройством необходимо обеспечить защиту от образования электростатического разряда

Общие указания по ремонту

1. Провождение ремонта приборов данной системы должно производиться только квалифицированным персоналом в специализированной мастерской.
3. Соблюдайте предписания предприятия по технике безопасности, а также национальные нормы.
5. Проводите ремонт только после того, как вы прочитали и поняли все информации, необходимые для данного процесса. Дополнительные документы: инструкция по тестированию, список запасных частей, общие инструкции по ремонту и проведению испытаний (815 080 109 3) Вы найдете на www.wabco-auto.com. Для этого необходимо задать номер нужного прибора или номер брошюры в INFORM.
7. Компания WABCO не принимает на себя какую-либо ответственность за работу или качество отремонтированных устройств.
2. Следуйте предписаниям и инструкциям изготовителя транспортного средства.
4. Используйте только запчасти, допущенные к использованию компанией Wabco или производителем транспортного средства.
6. Проконтролируйте каждый отремонтированный прибор- согласно инструкции по тестированию- на работоспособность и герметичность с помощью соответствующего оборудования.

ru

Изображение	Символ	Позиция	Значение	Замечания
	1	22, 10	23 ± 1,5 Nm	
	2	9	12 ± 1,5 Nm	
	3	14	6 ± 1 Nm	
	1			После ремонта может потребоваться процесс обучения. Эта процедура выполняется с помощью диагностического прибора VOLVO или системы диагностики Wabcowürth W.EASY (для TC, выпущенных в период с 2005 по 2013 гг.).
	2	X	830 502 087 4	Смажьте поверхности уплотнения / скольжения. GLK 112

SV

Signalord & symboler

- DANGER** FARA Omedelbar risk: svåra personskador eller dödsfall
- WARNING** VARNING Möjlig risk: Lätta eller medelsvåra personskador eller materiella skador
- CAUTION** VARNING Möjlig risksituation: Dödsfall eller svåra personskador
- Delar med inringat positionsnummer ingår i reparationsssatsen.

- Anvisningar/information för korrekt reparation
- Reparationsssatsen kan användas för apparater enligt tabellen.
- Dra åt elementet med angivet åtdragningsmoment.
- Vid hantering av dessa komponenter krävs skydd mot elektrostatisk urladdning (ESD).

Allmänna reparationsanvisningar

1. Reparationsarbeten på enheter i fordonssäkerhetssystem får endast genomföras av kvalificerad personal på behörig verkstad.
2. Beakta alltid fordonstillverkarens specifikationer och anvisningar.
3. Följ alltid företagets föreskrifter för förebyggande av olycksfall samt gällande nationella föreskrifter.
4. Används endast reservdelar som är godkända av WABCO eller fordonstillverkaren.
5. Börja inte med reparationsarbetena förrän du har läst igenom och förstått all nödvändig information. Nödvändiga extradokument: Kontrollanvisning, reservdelsblad, allmän reparation och kontrollinformation (815 070 109 3). Du hittar dokumenten på www.wabco-auto.com genom att mata in apparatens produktnummer eller dokumentnummer i INFORM.
6. Varje reparerad apparat ska kontrolleras på funktionsduglighet och täthet på en lämplig anordning enligt kontrollanvisningen.
7. WABCO ansvarar inte för reparerade enheters funktion eller kvalitet.

Bild	Symbol	Position	Värde	Kommentar
	1	22, 10	23 ± 1,5 Nm	
	2	9	12 ± 1,5 Nm	
	3	14	6 ± 1 Nm	
	1			Efter reparation kan det krävas en inläring. Denna kan genomföras med VOLVO Diagnose Tool eller Wabcowürth Diagnose W.EASY (för fordon av årsmodell 2005 till 2013).
	2	X	830 502 087 4	Smörj tätnings- och glidytor. GLK 112

zh





Symbols & Signal Words

- DANGER** 危险! 直接危险: 导致个人严重伤害或死亡
- WARNING** 小心! 可能危险: 导致较小或一般程度人员伤害或物品损失
- CAUTION** 警告! 可能危险: 导致个人严重伤害或死亡
- 修包中包含号码带有圆圈的零件。

- 用于正确维修的指导 and 信息。
- 根据表格所示, 修包可以用于相应的总成维修。
- 紧固件必须根据所指定的力矩上紧。
- 操作这些元部件需要静电放电(ESD)保护。





zh





1. 只有在专业维修店的有资质的人员被授权执行车辆安全系统的维修工作。
2. 完全遵循车辆制造商的规格和安装指导。
3. 遵循公司的相关事故预防条例和国家法规。
4. 仅使用于由威伯科公司或整车制造商发布的备件产品。
5. 当你已经阅读并已理解维修所需要的所有信息后，才能开始维修工作。此外需要的信息：试验指导，备件清单，通用维修和试验提示（815 010 109 3）可以在www.wabco-auto.com 找到。只需在其上键入产品号码或INFORM中的出版物号码。
6. 根据试验要求在适当的设备上，检测每个维修设备的功效和紧密性。
7. WABCO对经过修理的设备的功能或质量不承担任何责任。

图片	符号	零件	价值	注释
1	 1	22, 10	23 ± 1,5 Nm	
	 2	9	12 ± 1,5 Nm	
	 3	14	6 ± 1 Nm	
	 1			修理之后可能需要进行一次学习过程。该过程可采用VOLVO Diagnose Tool或者Wabcowürth Diagnose W.EASY (适用于制造年份2005至2013的车辆)来进行。
	 2	X	830 502 087 4	密封和滑动表面必须被润滑。GLK 112

tr





Semboller&belirti sözleri

-  **DANGER** TEHLİKE Tehlikeli durum: ciddi personel yaralanması veya ölüm riski.
-  **WARNING** DİKKAT Tehlike riski: hafif personel yaralanması veya maddi zarar.
-  **CAUTION** UYARI Ciddi personel yaralanması veya ölüm riski.
-  Yuvarlak içinde numarası belirtilen parça numaraları kit içerisinde bulunur.

-  Talimat/ Doğru tamir için bilgi
-  Tabloda belirtilen parçalar için kit kullanılabilir.
-  Vidalar özel tork değerine kadar sıkılmalıdır.
-  Bu bileşenle çalışmalarda elektrostatik deşarja (ESD'ye) karşı bir koruma kesinlikle gereklidir.





Genel tamir bilgisi





1. Araçların güvenlik sistemlerinde tamir işlemlerini yalnızca eğitim almış konusunda uzman personeller gerçekleştirebilir.
2. Araç üretici firma özellikler ve talimatlarına kesinlikle uyunuz.
3. Şirket emniyet kuralları ve ulusal regülasyonlarına uyunuz.
4. Sadece WABCO veya üretici firma tarafından yayınlanan yedek parçaları kullanın.
5. Tamire, tamir işlemi için gerekli olan tüm bilgileri okuyup anladıktan sonra başlayınız. Ayrıca gerekli olan dokümanlar: Test talimatı, yedek parça sayfası, genel tamir ve test bilgileri (815 140 109 3). Tümünü linki altında, online ürün kataloğu INFORM'da cihaza ait ürün numarasını veya baskı numarasını girerek bulabilirsiniz.
6. Tamir edilmiş her cihazı - test talimatına uygun şekilde - uygun bir donanımla işlevsellik ve sızdırmazlık konusunda kontrol edin.
7. WABCO tamir edilmiş bir cihazın işlevselliği veya kalitesi için hiçbir sorumluluk üstlenmemektedir.

Resim	Sembol	Parça	Değer	Yorumlar
1	 1	22, 10	23 ± 1,5 Nm	
	 2	9	12 ± 1,5 Nm	
	 3	14	6 ± 1 Nm	
	 1			Onarımdan sonra bir tanıma süreci gerekli olabilir. Bu süreç, VOLVO Diyagnoz Cihazı veya Wabcowürth Diyagnoz W.EASY Sistemi (imalat yılı 2005 ile 2013 arası olan araçlar için) ile gerçekleştirilebilir.
	 2	X	830 502 087 4	Conta ve sürtünme ile çalışan yüzeyler yağlanmalıdır. GLK 112

hu







Szimbólumok és Jelző Szavak

-  **DANGER** Közelgő vészhelyzet: súlyos személyi sérüléshez vagy halálhoz vezethet
-  **WARNING** Lehetséges vészhelyzet: kisebb vagy közepes személyi sérülés vagy anyagi kár keletkezhet
-  **CAUTION** Lehetséges vészhelyzet: súlyos személyi sérüléshez vagy halálhoz vezethet
-  Csak azok az alkatrészek amik be vannak karikázva, részei a javítókészletnek.

-  Utasítás / Információ a helyes szereléshez
-  A javító készlet a táblázatban szereplő egységekhez használható.
-  A rögzítő elemeket az előírt nyomatékkal kell megúzni
-  Az alkatrész kezelésekor megkövetelt a elektrosztatikus kisülés elleni védelem alkalmazása (ESD)









Általános Javítási Tippek

1. Csak megfelelő végzettségű személy vagy szakműhely van felhatalmazva hogy a jármű biztonsági rendszerén javítást eszközöljön.
3. Mindenképpen vegye figyelembe a gyártók vonatkozó balesetvédelmi előírásait és a nemzeti előírásokat is.
5. Minden esetben csak akkor kezdjen hozzá a javítási munkához, ha elolvasta és teljesen megértette a javítási utasítást! Ezekre a dokumentumokra lesz még szüksége: Vizsgálati Utasítás, Alkatrészek listája, Általános javítási és vizsgálati tippek (815 010 109 3) amiket a www.wabco-auto.com-on talál meg, a termék vagy a kiadvány cikkszámának begépelésével az INFORM-ba.
7. A WABCO nem vállal felelősséget a javított készülékek működéséért és minőségéért.
2. Mindenképpen kövesse a jármű gyártójának specifikációját és szerelési utasításait.
4. Csak a WABCO vagy a jármű gyártója által kereskedelmi forgalomban lévő alkatrészeket használjon.
6. Minden javított egységnél ellenőrizze a működési üzemállapotokat és az előírt meghúzási nyomatékokat a vizsgálati utasításnak megfelelően.

Kép	Szimbólum	Tétel	Érték	Megjegyzés
	 1	22, 10	23 ± 1,5 Nm	
	 2	9	12 ± 1,5 Nm	
	 3	14	6 ± 1 Nm	
	 1			A javítás után szükség lehet egy tanulási folyamatra. Ezt a folyamatot a VOLVO diagnosztikai eszközzel vagy a Wabcowürth W.EASY diagnosztikával (2005-2013 közt gyártott járművekhez) végezheti el.
	 2	X	830 502 087 4	A tömítő és csúszó felületeket mindenképp kenni kell. GLK 112

pt





Símbolos e Significados

-  **DANGER** Perigo! Risco de acidente iminente: lesão corporal grave e/ou risco de morte.
-  **WARNING** Cuidado! Possível situação de acidente: ferimentos leves/moderados e/ou danos materiais.
-  **CAUTION** Atenção! Possível situação de acidente: lesão corporal grave e/ou risco de morte.
-  Componentes que estão marcados com um círculo compõem o jogo de reparo.
-  Instrução/Informação para uma correta reparação.
-  O jogo de reparo pode ser utilizado nos produtos relacionados na tabela.
-  Parafusos/porcas devem ser montados de acordo com o torque especificado.
-  Antes do passo de trabalho seguinte, certifique-se de que todos os parafusos estão apertados com o binário de aperto correto.

pt





Dicas Gerais para Reparação





1. Por motivo de segurança, somente pessoas qualificadas devem efetuar reparação nos sistemas de freio do veículo.
2. Siga sempre as recomendações/especificações do fabricante do veículo.
3. Mantenha e siga as orientações de prevenção de acidentes vigentes e/ou impostas pelos órgãos competentes.
4. Use somente peças de reposição aprovadas pela WABCO ou pelo fabricante do veículo.
5. Somente inicie o trabalho de reparação após ler e entender todas as informações necessárias para realizar uma reparação. Documentos adicionais necessários: instrução de teste, lista de peças sobressalentes, dicas gerais de testes e reparação (815 130 109 3) podem ser encontrados no site www.wabco-auto.com ao inserir o número do produto.
6. Verificar cada produto reparado conforme instruções de teste, utilizando os equipamentos necessários e local adequado.
7. A WABCO não assume qualquer responsabilidade pela função ou qualidade de um equipamento reparado.

Figura	Símbolo	Item	Valor	Comentários
1	 1	22, 10	23 ± 1,5 Nm	
	 2	9	12 ± 1,5 Nm	
	 3	14	6 ± 1 Nm	
	 1			Após o reparo, poderá ser necessário um processo de programação (Teach-In). Este processo pode ser executado com a ferramenta de diagnóstico da VOLVO ou com a Wabcowürth W. EASY (para veículos fabricados entre 2005 e 2013).
	 2	X	830 502 087 4	Superfícies de vedação e deslizamento devem ser lubrificadas GLK 112

ro

Simboluri și cuvinte pentru avertizare

-  **DANGER** Situație de pericol iminentă: poate rezulta vătămare corporală gravă sau deces.
-  **WARNING** Posibilă situație de pericol: pot rezulta vătămări corporale minore sau medii sau pagube materiale
-  **CAUTION** Posibilă situație de pericol: poate rezulta vătămare corporală gravă sau deces
-  Pieșele cu numărul de articol încercuit sunt incluse în kit.

-  Instrucțiuni / Informare pentru o reparare corectă
-  Kitul poate fi folosit pentru dispozitive, conform tabelului.
-  Elementele de fixare trebuie să fie strânse la un moment specific.
-  Manipularea acestui component necesită protecție împotriva descărcărilor electro-statice (ESD)

Instrucțiuni generale referitoare la reparație

1. Numai personalul calificat al unui atelier de service specializat este autorizat să efectueze lucrări de reparații pe sistemul de siguranță al vehiculului.
2. Respectați obligatoriu instrucțiunile date de producătorul vehiculului.
3. Respectați prevederile firmei și cele naționale pentru prevenirea accidentelor.
4. Utilizați exclusiv piese de schimb autorizate de WABCO sau de producătorul autovehiculului.
5. Întotdeauna începeți lucrările de reparații numai după ce ați citit și înțeles toate informațiile necesare pentru reparație. Documente suplimentare necesare: Instrucțiuni de testare, Lista pieselor de schimb, Instrucțiuni generale pentru reparare și testare (815 110 109 3) pot fi găsite pe www.wabco-auto.com introducând codul dispozitivului în INFORM.
6. Verifică eficiența funcțională și etanșeitatea fiecărui echipament reparat pe o instalație adecvată în conformitate cu instrucțiunile de testare.
7. WABCO nu garantează sau nu răspunde pentru funcționarea și calitatea unui dispozitiv reparat.

ro

Imagine	Simbol	Articol	Valoare	Comentarii
	1	22, 10	23 ± 1,5 Nm	
	2	9	12 ± 1,5 Nm	
	3	14	6 ± 1 Nm	
	1			După reparare poate fi necesar un proces de „învățare”. Acest proces poate fi realizat cu instrumentul de diagnoză VOLVO sau cu WabcowürthW.EASY (pentru autovehiculele din anii de fabricație din 2005 până în 2013).
	2	X	830 502 087 4	Suprafețele de etanșare și alunecare trebuie să fie lubrificate. GLK 112

ko

Symbols & Signal Words

- DANGER** 급박한 위험 상황: 심각한 상해 또는 사망에 이르게 할 수도 있습니다.
- WARNING** 잠재적 위험 상황: 경미하거나 완화된 부상 또는 물질적 손실을 입을 수 있습니다.
- CAUTION** 잠재적 위험 상황: 심각한 상해 또는 사망에 이르게 할 수도 있습니다.
- 본 키트에는 원숫자로 표기된 제품들만 포함되어 있습니다.

- 올바른 수리를 위한 설명 / 정보
- 표를 참조하여 제품에 대한 키트를 사용할 수 있습니다.
- 체결품들은 명시된 토크값으로 체결되어야 합니다.
- 이 부품을 다루기 위해서 정전기 방전 보호가 필요합니다.

1. 자격이 있는 전문 정비사만이 차량의 안전 시스템을 수리할 수 있습니다.
2. 꼭 차량제조사와 사양과 지침서를 따르십시오.
3. 회사의 사고예방 규제와 국내 법적 규제를 지키십시오.
4. 와브코 또는 차량 제조사로부터 제공된 예비부품만을 사용하십시오.
5. 항상 수리에 필요한 모든 정보를 읽고 이해했을 때만 작업을 시작하십시오. 추가적으로 필요한 간행물: 검사지침, 예비부품 리스트, 일반적인 수리 및 검사 참고사항 (815 010 109 3)은 와브코 홈페이지 www.wabco-auto.com의 INFORM으로 들어가셔서 제품번호 또는 간행물 번호를 조회하여 찾으실 수 있습니다.
6. 기능적 효율과 견고함을 위해 검사지침에 따라 각 수리장비들을 적절한 설비위에서 체크해 보시기 바랍니다.
7. 와브코는 수리된 제품의 품질과 기능에 대해 어떠한 책임도 지지 않습니다.

그림	기호	품목	값	주석
	1	22, 10	23 ± 1,5 Nm	
	2	9	12 ± 1,5 Nm	
	3	14	6 ± 1 Nm	
	1			수리 후 설정 과정이 필요할 수 있습니다. 이 과정은 VOLVO 진단 툴이나 Wabcowürth 진단 W.EASY(2005년부터 2013년식 차량용)으로 실행될 수 있습니다.
	2	X	830 502 087 4	밀폐되어 미끄러져 움직이는 부위의 표면에는 윤활제를 도포하십시오. GLK 112