

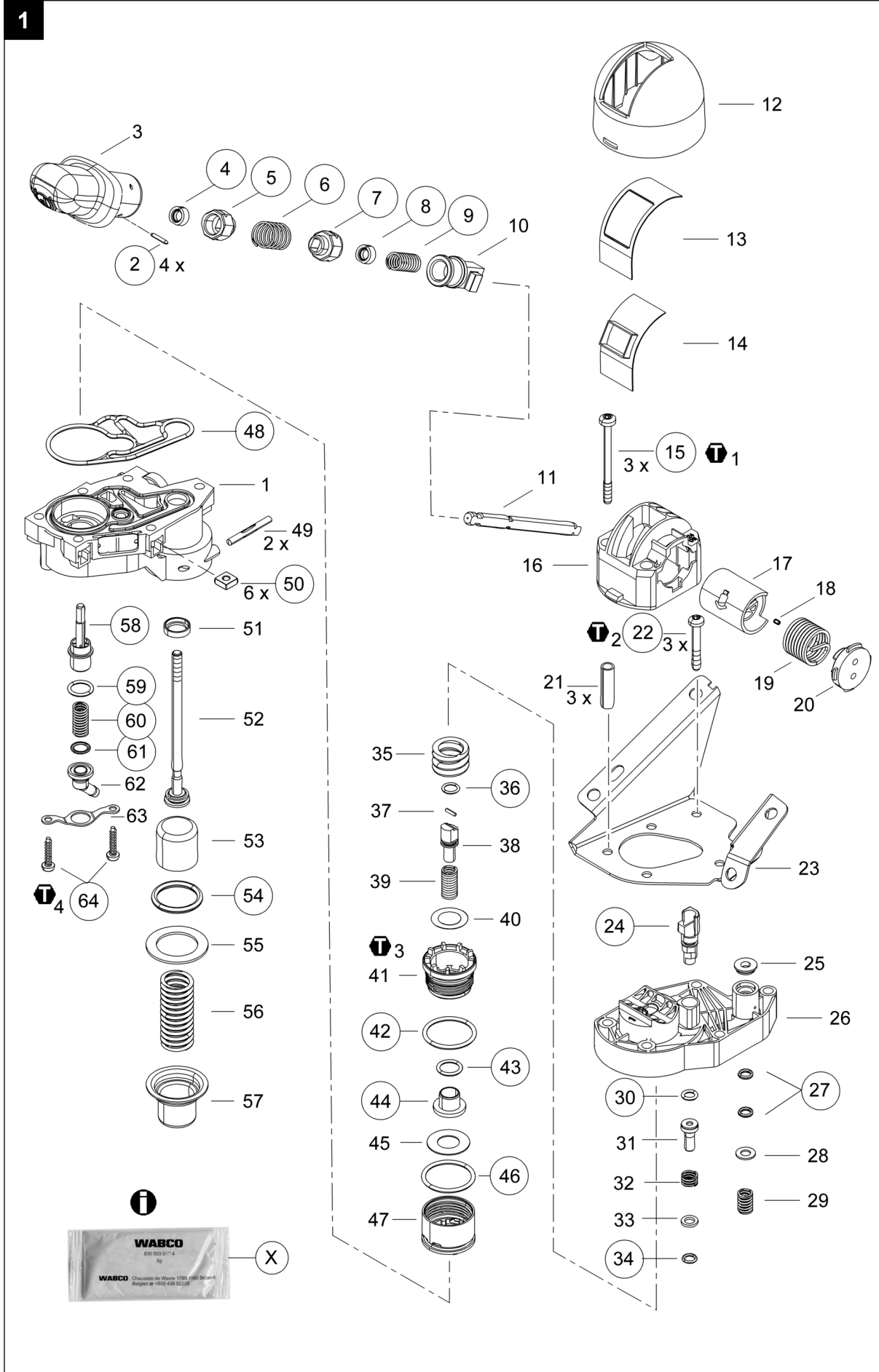

961 724 204 0
961 724 205 0

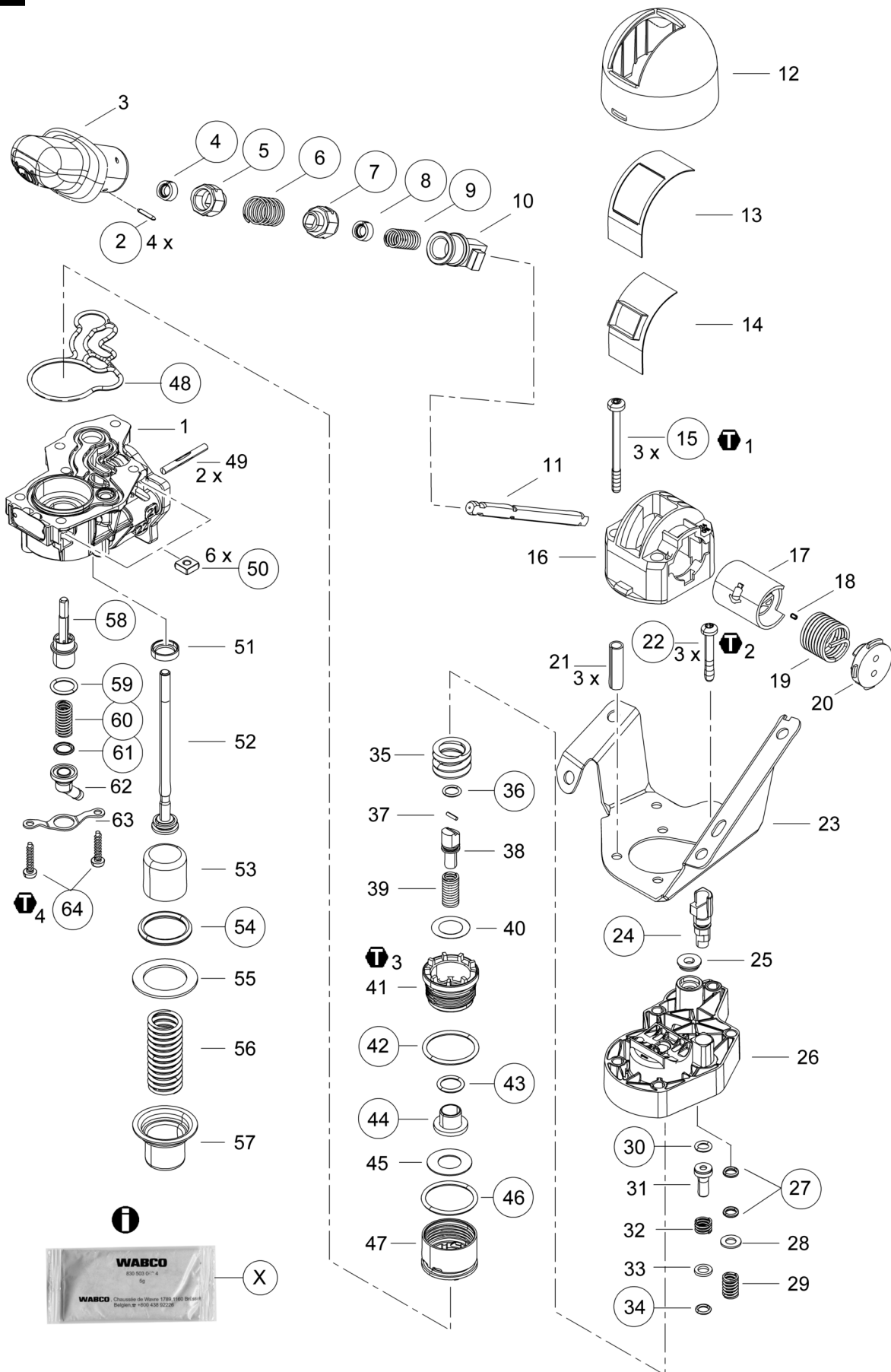







2



de





Signalwörter & Symbole

-  **Danger!** GEFAHR! Unmittelbar drohende Gefährdung: Schwere Personenschäden oder Tod
-  **Warning!** VORSICHT Mögliche Gefahrensituation: Leichte oder mittelschwere Personenschäden oder Sachschäden als Folge
-  **Caution!** WARNUNG Mögliche Gefahrensituation: Tod oder schwere Personenschäden als Folge
-  Teile mit Kreis um die Positionsnummer sind im Reparatursatz enthalten.

-  Anweisung / Information für eine korrekte Reparatur
-  Der Reparatursatz kann für Geräte entsprechend Tabelle verwendet werden
-  Element mit angegebenen Drehmoment anziehen.





Allgemeine Reparaturhinweise



1. Reparaturarbeiten an Geräten eines Fahrzeugsicherheits-Systems darf nur qualifiziertes Personal einer Fachwerkstatt durchführen.
3. Halten Sie Unfallverhütungsvorschriften des Betriebes sowie nationale Vorschriften ein.
5. Beginnen Sie die Reparatur erst dann, wenn Sie alle Informationen, die für die Reparatur notwendig sind, gelesen und verstanden haben. Zusätzlich benötigte Dokumente: Prüfanweisung, Ersatzteilblatt, Allgemeine Reparatur- und Prüfhinweise (815 020 109 3) zu finden auf www.wabco-auto.com mittels Eingabe der Produktnummer des Gerätes bzw. Druckschriftennummer in INFORM.
2. Leisten Sie den Vorgaben und Anweisungen des Fahrzeugherstellers unbedingt Folge.
4. Verwenden Sie ausschließlich von WABCO oder vom Fahrzeughersteller freigegebene Ersatzteile.
6. Prüfen Sie jedes reparierte Gerät - gemäß Prüfanweisung - an einer adäquaten Einrichtung auf Funktionstüchtigkeit und Dichtigkeit.

Bild	Symbol	Position	Wert	Hinweis
1+2	 1	15	4 +1 Nm	
1+2	 2	22	4 +1 Nm	
1+2	 3	41	4 +1 Nm	
1+2	 4	64	2.6 +0.4 Nm	
1+2		X	RHF 1 (830 502 076 4)	Fetten Sie die Dicht- und Gleitflächen ein.
1	für Geräte	961 724 204 0		
2	für Geräte	961 724 205 0		

en

Symbols & Signal Words





-  **Danger!** Imminent hazard situation: serious personal injury or death as a result
-  **Warning!** CAUTION Possible hazard situation: minor or moderate personal injury or material loss as a result
-  **Caution!** Possible hazard situation: serious personal injury or death as a result
-  Parts having item numbers with circles are included in the kit.

-  Instruction/Information for a correct repair
-  The kit can be used for devices according table.
-  Fasteners must be tightened to a specific torque.

General Repair Hints





1. Only qualified personnel of a specialist workshop are authorized to perform repair work on a vehicle's security system.
3. Keep to company's relevant accident prevention regulations and national regulations.
5. Always start repair work only when you have read and understood all information required for repair. Documents additionally needed: Test Instruction, Spare Parts List, General Repair and Test Hints (815 010 109 3) to be found on www.wabco-auto.com by entering product number of the device or the publication number in INFORM.
2. Absolutely follow specifications and instructions of vehicle manufacturer.
4. Use only spare parts released by WABCO or vehicle manufacturer.
6. Check each repaired equipment for functional efficiency and tightness on an adequate facility according to the test instruction.

en

Picture	Symbol	Item	Value	Hint
1+2	 1	15	4 +1 Nm	
1+2	 2	22	4 +1 Nm	
1+2	 3	41	4 +1 Nm	
1+2	 4	64	2.6 +0.4 Nm	
1+2		X	RHF 1 (830 502 076 4)	Sealing and sliding surfaces have to be lubricated
1	for devices	961 724 204 0		
2	for devices	961 724 205 0		

es

Símbolos & Palabras de aviso

-  **Danger!** PELIGRO Situación de peligro inminente: Pueden ocasionarse daños personales graves o incluso mortales
-  **Warning!** CUIDADO Posible situación de peligro: Pueden ocasionarse daños personales leves o moderados o pérdidas materiales
-  **Caution!** ADVERTENCIA Posible situación de peligro: Pueden ocasionarse daños personales graves o incluso mortales
-  Los componentes incluidos en el kit son los números que aparecen con círculo.





 Instrucciones/Información para una correcta reparación

 El kit puede ser utilizado en los equipos que aparecen en la tabla.

 Los cierres deben apretarse a un par de apriete determinado.





Consejos generales de reparación



1. Sólo el personal cualificado de un taller especializado está autorizado para realizar las tareas en sistemas de seguridad de vehículos.
2. Atenerse exactamente a las indicaciones e instrucciones del fabricante del vehículo.
3. Siga las regulaciones y normas acerca de prevención de riesgos laborales de su empresa y de su país.
4. Utilice piezas de repuesto suministradas por WABCO o el fabricante del vehículo.
5. Comience la reparación sólo cuando haya leído y comprendido las instrucciones de reparación. Documentos adicionales necesarios: Instrucciones de comprobación, listas de despiece, consejos generales de comprobación y reparación (815 040 109 3), los cuales pueden encontrarse en www.wabco-auto.com, introduciendo la referencia del aparato o la referencia de la publicación en la aplicación INFORM.
6. Compruebe la eficacia de funcionamiento y de ajuste de cada equipo reparado en unas instalaciones adecuadas según las instrucciones de comprobación.

Dibujo	Símbolo	Posición	Valor	Nota
1+2	 1	15	4 +1 Nm	
1+2	 2	22	4 +1 Nm	
1+2	 3	41	4 +1 Nm	
1+2	 4	64	2.6 +0.4 Nm	
1+2		X	RHF 1 (830 502 076 4)	Las juntas y las superficies deslizantes deben lubricarse.
1	para aparatos	961 724 204 0		
2	para aparatos	961 724 205 0		

fr













Symboles & Significations

-  **Danger!** DANGER Situation de danger imminente : Risque de dommage corporel sérieux ou de mort
-  **Warning!** ATTENTION Situation de danger probable : Risque de dommage corporel mineur ou modéré ou perte de matériel
-  **Caution!** AVERTISSEMENT Situation de danger probable : Risque de dommage corporel sérieux ou de mort
-  Les composants avec repères entourés sont inclus dans le kit.

-  Instruction/Information pour une réparation correcte
-  Le kit peut être utilisé pour les appareils indiqués sur le Feuille.
-  Les fixations doivent être serrées à un couple spécifique.





Conseils Généraux De Réparation



1. Uniquement le personnel qualifié d'un atelier agréé WABCO est autorisé à effectuer la réparation sur les systèmes de sécurité d'un véhicule.
3. Veillez aux règlements de prévention des accidents indiqués par votre société et aux règlements nationaux.
5. Commencez toujours le travail de réparation seulement après avoir lu et compris toutes les informations indiquées pour la réparation. Documentation complémentaire nécessaire : Instruction d'essai, liste des pièces détachées, instructions de réparation et conseils d'essai (815 030 109 3) en tapant la référence du produit ou le numéro de la publication dans INFORM sur internet : www.wabco-auto.com
2. Respecter toujours les prescriptions et instructions du constructeur du véhicule.
4. Employez seulement les pièces de rechange WABCO ou du constructeur du véhicule.
6. Examinez chaque appareil réparé pour s'assurer de l'efficacité fonctionnelle et de l'étanchéité selon l'instruction d'essai.

Image	Symbole	Mention	valeur	conseil
	 1	15	4 +1 Nm	
	 2	22	4 +1 Nm	
	 3	41	4 +1 Nm	
	 4	64	2.6 +0.4 Nm	
		X	RHF 1 (830 502 076 4)	Les surfaces d'étanchéité et de frottement doivent être graissées
	pour appareils	961 724 204 0		
	pour appareils	961 724 205 0		

it

Simboli & Segnali





-  **Danger!** PERICOLO Imminente situazione di rischio: serie ferite personali fino anche alle morte
-  **Warning!** PRUDENZA Possibili situazioni di pericolo: possibili lievi ferite o perdita di materiale
-  **Caution!** AVVERTENZA Possibili situazioni di pericolo: serie ferite personali fino anche alle morte
-  I componenti indicati con un numero cerchiato, sono inclusi nel kit.

-  Istruzioni/Informazioni per una corretta riparazione
-  Il kit può essere usato per gli articoli secondo la tabella.
-  I fissaggi devono essere stretti ad una coppia di serraggio specifica.

it







Suggerimenti Generali Di Riparazione

1. Soltanto il personale qualificato delle officine specializzate è autorizzato ad effettuare le riparazioni sui sistemi di sicurezza dei veicoli.
2. E' assolutamente necessario seguire le istruzioni e le specifiche del costruttore del veicolo.
3. Attenersi alle norme nazionali e aziendali in merito alla prevenzione degli infortuni.
4. Usare solo ricambi originali WABCO o del costruttore del veicolo.
5. Effettuare la riparazione solamente dopo aver letto e capito tutte le informazioni richieste per la riparazione. Ulteriori informazioni necessarie: istruzioni di collaudo, catalogo dei ricambi, cenni generali sulla riparazione e test (815 050 109 3) possono essere trovati sul sito www.wabco-auto.com alla voce INFORM entrando per codice dell'apparecchio o per numero della pubblicazione.
6. Controllare la funzionalità e l'efficienza di ogni apparecchiatura riparata secondo le istruzioni riportate nel manuale di collaudo.

Figura	Simbolo	Particolare	Valore	Suggerimento
1+2	 1	15	4 +1 Nm	
1+2	 2	22	4 +1 Nm	
1+2	 3	41	4 +1 Nm	
1+2	 4	64	2.6 +0.4 Nm	
1+2	 i	X	RHF 1 (830 502 076 4)	Sealing and sliding surfaces have to be lubricated
1	per apparecchi	961 724 204 0		
2	per apparecchi	961 724 205 0		

ru

Знаки & символы

-  **Danger!** ОПАСНО Прямая угроза аварийной ситуации: влечет за собой смерть или тяжелые повреждения
-  **Warning!** ОСТОРОЖНО Опасная ситуация: последствиями являются легкие повреждения или повреждения средней тяжести, а также материальный ущерб
-  **Caution!** ПРЕДУПРЕЖДЕНИЕ Опасная ситуация: влечет за собой смерть или тяжелые повреждения
-  Номера частей, обведенные кружком, Вы найдете в ремкомплекте.
-  Указание/информация для проведения надлежащего ремонта
-  Ремкомплект может быть использован для приборов соответственно таблице
-  Элемент необходимо подтянуть с помощью заданного момента сопротивления.

Общие указания по ремонту





1. Проведение ремонта приборов данной системы должно производиться только квалифицированным персоналом в специализированной мастерской.
2. Следуйте предписаниям и инструкциям изготовителя транспортного средства.
3. Соблюдайте предписания предприятия по технике безопасности, а также национальные нормы.
4. Используйте только запчасти, допущенные к использованию компанией Wabco или производителем транспортного средства.
5. Проводите ремонт только после того, как вы прочитали и поняли все информации, необходимые для данного процесса. Дополнительные документы: инструкция по тестированию, список запасных частей, общие инструкции по ремонту и проведению испытаний (815 080 109 3) Вы найдете на www.wabco-auto.com. Для этого необходимо задать номер нужного прибора или номер брошюры в INFORM.
6. Проконтролируйте каждый отремонтированный прибор- согласно инструкции по тестированию- на работоспособность и герметичность с помощью соответствующего оборудования.



ru

Изображение	Символ	Позиция	Значение	Указание
1+2	 1	15	4 +1 Nm	
1+2	 2	22	4 +1 Nm	
1+2	 3	41	4 +1 Nm	
1+2	 4	64	2.6 +0.4 Nm	
1+2		X	RHF 1 (830 502 076 4)	Смажьте поверхности уплотнения / скольжения
1	для приборов	961 724 204 0		
2	для приборов	961 724 205 0		

pt





Símbolos e Significados

-  **Perigo!** ATENÇÃO! Risco de acidente iminente: lesão corporal grave e/ou risco de morte.
-  **Atenção!** ATENÇÃO! Possível situação de acidente: ferimentos leves/moderados e/ou danos materiais.
-  **Cuidado!** ATENÇÃO! Possível situação de acidente: lesão corporal grave e/ou risco de morte.
-  Componentes que estão marcados com um círculo compõem o jogo de reparo.

-  Instrução/Informação para uma correta reparação.
-  O jogo de reparo pode ser utilizado nos produtos relacionados na tabela.
-  Parafusos/porcas devem ser montados de acordo com o torque especificado.

Dicas Gerais para Reparação

1. Por motivo de segurança, somente pessoas qualificadas devem efetuar reparação nos sistemas de freio do veículo.
2. Mantenha e siga as orientações de prevenção de acidentes vigentes e/ou impostas pelos órgãos competentes.
3. Somente inicie o trabalho de reparação após ler e entender todas as informações necessárias para realizar uma reparação. Documentos adicionais necessários: instrução de teste, lista de peças sobressalentes, dicas gerais de testes e reparação (815 010 109 3) podem ser encontrados no site www.wabco-auto.com ao inserir o número do produto.
4. Siga sempre as recomendações/especificações do fabricante do veículo.
5. Use somente peças de reposição aprovadas pela WABCO ou pelo fabricante do veículo.
6. Verificar cada produto reparado conforme instruções de teste, utilizando os equipamentos necessários e local adequado.

Figura	Símbolo	Item	Valor	Sugestão
1+2	 1	15	4 +1 Nm	
1+2	 2	22	4 +1 Nm	
1+2	 3	41	4 +1 Nm	
1+2	 4	64	2.6 +0.4 Nm	
1+2		X	RHF 1 (830 502 076 4)	Superfícies de vedação e deslizamento devem ser lubrificadas
1	Para conjuntos	961 724 204 0		
2	Para conjuntos	961 724 205 0		