

1

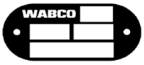

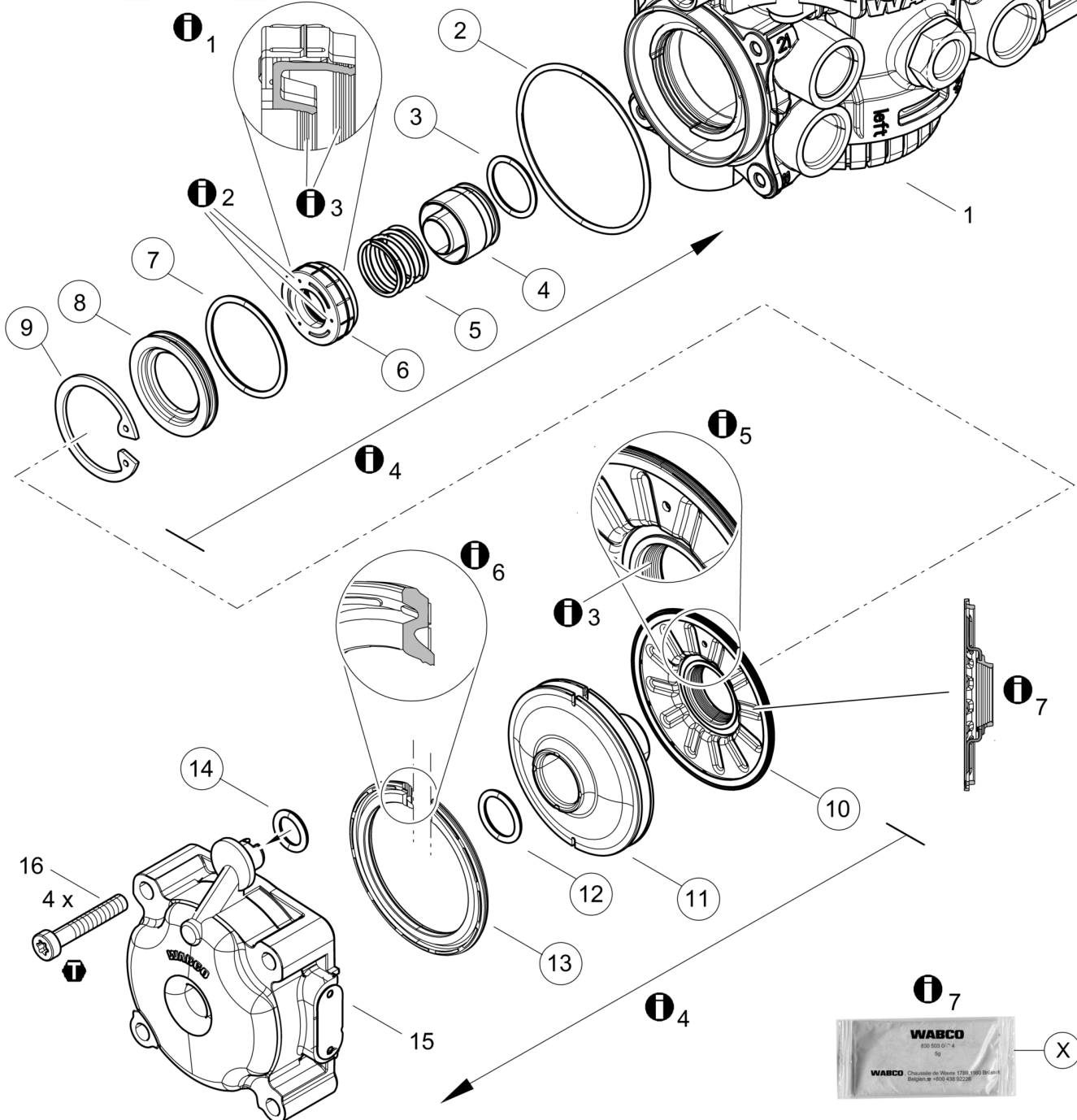

<http://www.wabco.info/i/158>

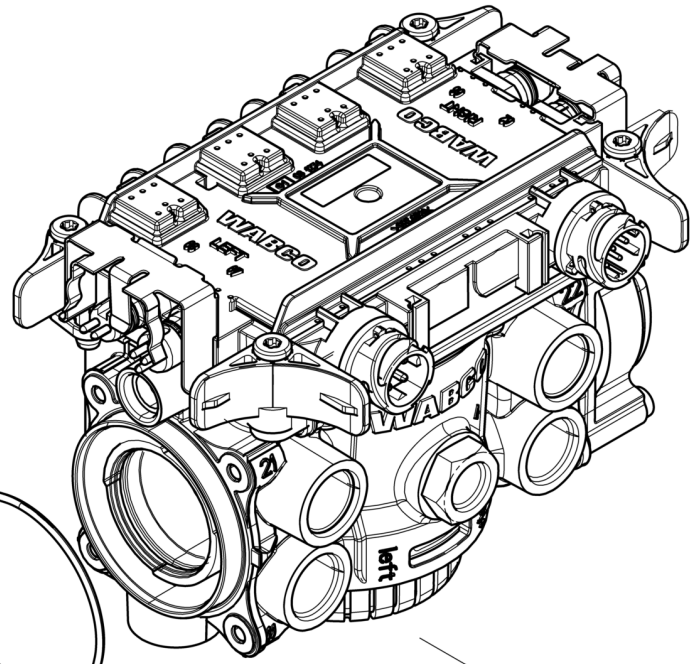
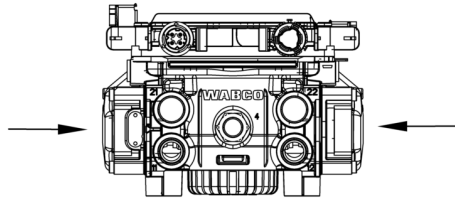

CS











Signální slova a symboly

-  **DANGER** NEBEZPEČÍ Bezprostředně hrozící nebezpečí: těžká újma na zdraví nebo smrt
-  **WARNING** POZOR Možná nebezpečná situace: jako následek lehká nebo středně těžká újma na zdraví nebo poškození majetku
-  **CAUTION** VÝSTRAHA Možná nebezpečná situace: jako následek těžká újma na zdraví nebo smrt
-  Díly, které mají číslo pozice v kroužku, jsou obsažené v opravárenské sadě.

-  Instrukce / informace ke správnému provedení opravy
-  Opravárenskou sadu je možné použít pro přístroje uvedené v tabulce.
-  Prvek utáhněte uvedeným točivým momentem příp. pomocí kontroly úhlu natočení.





Všeobecné pokyny k opravám



1. Opravárenské práce na přístrojích systému, který má vliv na bezpečnost vozidla, smí provádět pouze kvalifikovaný personál odborné servisní dílny.
3. Dodržujte předpisy BOZP podniku a národní předpisy.
5. S opravou začněte teprve tehdy, až všechny informace nutné pro opravu přečtete a porozumíte jim. Další potřebné dokumenty: zkušební postup, list náhradních dílů, všeobecné pokyny pro opravu a kontrolu (815 150 109 3) naleznete na internetových stránkách: www.wabco-auto.com, když v databázi INFORM zadáte produktové číslo přístroje nebo číslo dokumentu.
2. Postupujte bezpodmínečně podle pokynů a instrukcí výrobce vozidla.
4. Používejte výhradně náhradní díly od firmy WABCO nebo díly schválené výrobcem vozidla.
6. Na adekvátním zařízení přezkoušejte – podle zkušebního postupu – každý opravený přístroj na funkčnost a těsnost.

Obrázek	Symbol	Pozice	Hodnota	Instrukce
				Během všech opravárenských prací dbejte na maximální čistotu.
		16	2,5 + 1 Nm	
	 1			Použijte podle potřeby.
	 2	6		Otvory nemažte tukem.
	 3	6		Tuto oblast nemažte tukem.
	 4			Směr (orientace) montáže
	 5	10		Otvor umístěte ve směru na pozici 14.
	 6	13		Dbejte na správnost montážní polohy.
	 7	10		Dbejte na správnost montážní polohy.
	 8	2; 3; 7; 8; 10; 12; 13; 14		Namažte tukem pouze jen uvedenou součást. 8305021014, Isoflex Topas L 32

de

Signalwörter & Symbole

-  **DANGER** GEFAHR Unmittelbar drohende Gefährdung: Schwere Personenschäden oder Tod
-  **WARNING** VORSICHT Mögliche Gefahrensituation: Leichte oder mittelschwere Personenschäden oder Sachschäden als Folge
-  **CAUTION** WARNUNG Mögliche Gefahrensituation: Tod oder schwere Personenschäden als Folge
-  Teile mit Kreis um die Positionsnummer sind im Reparatursatz enthalten.

-  Anweisung / Information für eine korrekte Reparatur
-  Der Reparatursatz kann für Geräte entsprechend Tabelle verwendet werden.
-  Element mit angegebenen Drehmoment bzw. Drehwinkel anziehen.

de

Allgemeine Reparaturhinweise

1. Reparaturarbeiten an Geräten eines Fahrzeug-Sicherheitssystems darf nur qualifiziertes Personal einer Fachwerkstatt durchführen.
2. Leisten Sie den Vorgaben und Anweisungen des Fahrzeugherstellers unbedingt Folge.
3. Halten Sie Unfallverhütungsvorschriften des Betriebes sowie nationale Vorschriften ein.
4. Verwenden Sie ausschließlich von WABCO oder vom Fahrzeughersteller freigegebene Ersatzteile.
5. Beginnen Sie die Reparatur erst dann, wenn Sie alle Informationen, die für die Reparatur notwendig sind, gelesen und verstanden haben. Zusätzlich benötigte Dokumente: Prüfanweisung, Ersatzteilblatt, Allgemeine Reparatur- und Prüfhinweise (815 020 109 3) zu finden auf www.wabco-auto.com mittels Eingabe der Produktnummer des Gerätes bzw. Druckschriftennummer in INFORM.
6. Prüfen Sie jedes reparierte Gerät – gemäß Prüfanweisung – an einer adäquaten Einrichtung auf Funktionstüchtigkeit und Dichtigkeit.

Bild	Symbol	Position	Wert	Hinweis
1				Achten sie während der gesamten Reparaturarbeiten auf äußerste Sauberkeit.
		16	2,5 + 1 Nm	
		1		Zu verwenden nach Bedarf.
		2	6	Bohrungen nicht einfetten
		3	6	Diesen Bereich fetten
		4		Montagerichtung
		5	10	Positionieren Sie die Bohrung in Richtung auf Position 14.
		6	13	Einbaulage beachten.
		7	10	Einbaulage beachten.
		2; 3; 7; 8; 10; 12; 13; 14		Fetten Sie ausschließlich die genannte Position ein. 8305021014, Isoflex Topas L 32

en

Symbols & Signal Words

- | | |
|---|---|
| <p> DANGER Imminent hazard situation: serious personal injury or death as a result</p> <p> WARNING Possible hazard situation: minor or moderate personal injury or material loss as a result</p> <p> CAUTION Possible hazard situation: serious personal injury or death as a result</p> <p> Parts having item numbers with circles are included in the kit.</p> | <p> Instruction / Information for a correct repair</p> <p> The kit can be used for devices according table.</p> <p> Tighten element with specified torque or angle of rotation.</p> |
|---|---|

General Repair Hints

1. Only qualified personnel of a specialist workshop are authorized to perform repair work on a vehicle's security system.
2. Absolutely follow specifications and instructions of vehicle manufacturer.
3. Keep to company's relevant accident prevention regulations and national regulations.
4. Use only spare parts released by WABCO or vehicle manufacturer.
5. Always start repair work only when you have read and understood all information required for repair. Documents additionally needed: Test Instruction, Spare Parts List, General Repair and Test Hints (815 010 109 3) to be found on www.wabco-auto.com by entering product number of the device or the publication number in INFORM.
6. Check each repaired equipment for functional efficiency and tightness on an adequate facility according to the test instruction.

en

Picture	Symbol	Item	Value	Hint
				During repair work make sure that your environment is very clean.
		16	2,5 + 1 Nm	
		1		To be used as required as occasion demands.
		2	6	Keep bores free of grease
		3	6	Grease this area
		4		Assembly direction
		5	10	Adjust bore in direction to item 14
		6	13	Observe installation position.
		7	10	Observe installation position.
		8	2; 3; 7; 8; 10; 12; 13; 14	Solely grease named item. 8305021014, Isoflex Topas L 32

es

Símbolos & Palabras de aviso

- DANGER** PELIGRO Situación de peligro inminente: Pueden ocasionarse daños personales graves o incluso mortales
- WARNING** CUIDADO Posible situación de peligro: Pueden ocasionarse daños personales leves o moderados o pérdidas materiales
- CAUTION** ADVERTENCIA Posible situación de peligro: Pueden ocasionarse daños personales graves o incluso mortales
- Los componentes incluidos en el kit son los números que aparecen con círculo.

- Instrucciones/Información para una correcta reparación
- El kit puede ser utilizado en los equipos que aparecen en la tabla.
- Apretar el elemento con el par de apriete o ángulo de giro indicado.

Consejos generales de reparación

1. Sólo el personal cualificado de un taller especializado está autorizado para realizar las tareas de reparación en los sistemas de seguridad de los vehículos.
3. Siga las regulaciones y normas acerca de prevención de riesgos laborales de su empresa y de su país.
5. Comience la reparación sólo cuando haya leído y comprendido las instrucciones de reparación. Documentos adicionales necesarios: Instrucciones de comprobación, listas de despiece, consejos generales de comprobación y reparación (815 040 109 3), los cuales pueden encontrarse en www.wabco-auto.com, introduciendo la referencia del aparato o la referencia de la publicación en la aplicación INFORM.
2. Atenerse exactamente a las indicaciones e instrucciones del fabricante del vehículo.
4. Utilice piezas de repuesto suministradas por WABCO o el fabricante del vehículo.
6. Compruebe la eficacia de funcionamiento y de ajuste de cada equipo reparado en unas instalaciones adecuadas según las instrucciones de comprobación.

es

Dibujó	Símbolo	Posición	Valor	Consejo
1				Durante los trabajos de reparación asegurarse que la zona de trabajo esté muy limpia.
		16	2,5 + 1 Nm	
		1		Para ser usado tan requerido como las demandas de la ocasión.
		2	6	No engrasar los orificios.
		3	6	Engrasar esta área
		4		La dirección de la asamblea
		5	10	Posicionar el orificio en dirección a la posición 14.
		6	13	Prestar atención a la posición de instalación.
		7	10	Prestar atención a la posición de instalación.
		8	2; 3; 7; 8; 10; 12; 13; 14	Engrase exclusivamente el componente indicado 8305021014, Isoflex Topas L 32

fr

Symboles & Significations

- DANGER** DANGER Situation de danger imminent : Danger de mort ou de dommage corporel sérieux.
- WARNING** ATTENTION Situation de danger probable : Risque de dommage corporel mineur ou modéré ou perte de matériel.
- CAUTION** AVERTISSEMENT Situation de danger de danger probable : Danger de mort ou de dommages corporel sérieux
- Les composants avec repères entourés sont inclus dans le kit.

Instruction/Information pour une réparation correcte

Le kit peut être utilisé pour les appareils indiqués sur le Feuillelet.

Serrer l'élément avec le couple et la position angulaire indiqués.

Conseils généraux de réparation

1. Uniquement le personnel qualifié d'un atelier agréé WABCO est autorisé à effectuer la réparation sur les systèmes de sécurité d'un véhicule.
2. Respecter toujours les prescriptions et instructions du constructeur du véhicule.
3. Veillez aux règlements de prévention des accidents indiqués par votre société et aux règlements nationaux.
4. Employez seulement les pièces de rechange WABCO ou du constructeur du véhicule.
5. Commencez toujours le travail de réparation seulement après avoir lu et compris toutes les informations indiquées pour la réparation. Documentation complémentaire nécessaire : Instruction d'essai, liste des pièces détachées, instructions de réparation et conseils d'essai (815 030 109 3) en tapant la référence du produit ou le numéro de la publication dans INFORM sur internet : www.wabco-auto.com
6. Examinez chaque appareil réparé pour s'assurer de l'efficacité fonctionnelle et de l'étanchéité selon l'instruction d'essai.

fr

Image	Symbole	Position	Valeur	Conseil
				Pendant la réparation assurez vous de la propreté de l'environnement.
		16	2,5 + 1 Nm	
		1		Application suivant besoin.
		2		Ne pas lubrifier les trous.
		3		Lubrifier cette zone
		4		Sens du montage
		5		Positionner le trou vers la position 14.
		6		Faire attention à la position de montage.
		7		Faire attention à la position de montage.
		2; 3; 7; 8; 10; 12; 13; 14		Graisser cette pièce. 8305021014, Isoflex Topas L 32

hr

Simboli & Značenja

DANGER OPREZ Neposredna rizična situacija: moguće ozbiljno ozljeđivanje ili smrt

WARNING OPASNOST neposredna rizična situacija: moguće manje ozljeđivanje materijalna šteta

CAUTION UPOZORENJE Neposredna rizična situacija: moguće ozbiljno ozljeđivanje ili smrt

Dijelovi uređaja čiji su brojevi zaokruženi nalaze se u kompletu..

Informacija o ispravnom popravku.

Set može biti korišten za uređaje prema tabeli.

Zategnite element primjenom navedenog zakretnog momenta ili zakretnog kuta.





Opće upute o popravcima



1. Samo kvalificirane osobe istručnjaci smiju popravljati siguronosne sustave na vozilu.
2. U potpunosti slijedi specifikacije i upute proizvođača vozila.
3. Provodi tvrtkine siguronosne propise kao i nacionalne propise o sigurnosti
4. Koristi rezervne dijelove proizvedene od WABCA ili proizvođača vozila..
5. Popravak počni tek nakon što pročitaš i shvatiš upute o popravku. Potrebni dokumenti: Instrukcije o testiranju, Lista rezervnih dijelova, Opće natuknice o popravku i testiranju (815 010 109 3) mogu se naći na www.wabco-auto.com nakon upisa kataloškog broja proizvoda ili publikacije u INFORM-u.
6. Provjeri svaki popravljani uređaj kako radi i da li je zategnuto sve kako treba prema odgovarajućim uputama o testiranju proizvoda.

Slika	Simbol	Pojednost	Vrijednost	Naznaka
				Provjeri čistoću prostora prije popravka. Okoliš mora biti vrlo čist.
		16	2,5 + 1 Nm	
		1		Koristiti kako je zahtijevano prema određenim slučajevima.
		2		Ne namašćujte provrte.
		3		Ovo područje masti
		4		Smjer ugradnje.
		5		Pozicionirajte provrt u smjeru u položaju 14.
		6		Provjeri položaj ugradnje.
		7		Provjeri položaj ugradnje.
		2; 3; 7; 8; 10; 12; 13; 14		Lagano podmazati samo ovaj dio. 8305021014, Isoflex Topas L 32

it











Simboli e Segnali

-  **DANGER** PERICOLO Imminente situazione di rischio: serie ferite personali fino anche alle morte
-  **WARNING** PRUDENZA Possibili situazioni di pericolo: possibili lievi ferite o perdita di materiale
-  **CAUTION** AVVERTENZA Possibili situazioni di pericolo: serie ferite personali fino anche alle morte
-  I componenti indicati con un numero cerchiato, sono inclusi nel kit.

-  Istruzioni/Informazioni per unacorretta riparazione
-  Il kit può essere usato per gli articoli secondo la tabella.
-  Serrare l'elemento con la coppia/angolo di rotazione indicati.





Suggerimenti per la riparazione



1. Soltanto il personale qualificato delle officine specializzate è autorizzato ad effettuare le riparazioni sui sistemi di sicurezza dei veicoli.
3. Attenersi alle norme nazionali e aziendali in merito alla prevenzione degli infortuni.
5. Effettuare la riparazione solamente dopo aver letto e capito tutte le informazioni richieste per la riparazione. Ulteriori informazioni necessarie: istruzioni di collaudo, catalogo dei ricambi, cenni generali sulla riparazione e test (815 050 109 3) possono essere trovati sul sito www.wabco-auto.com alla voce INFORM entrando per codice del dell'apparecchio o per numero della pubblicazione.
2. E' assolutamente necessario seguire le istruzioni e le specifiche del costruttore del veicolo.
4. Usare solo ricambi originali WABCO o del costruttore del veicolo.
6. Controllare la funzionalità e l'efficienza di ogni apparecchiatura riparata secondo le istruzioni riportate nel manuale di collaudo.

Figura	Simbolo	Particolare	Valore	Suggerimento
1				Durante la riparazione assicurati che il luogo di lavoro sia pulito.
		16	2,5 + 1 Nm	
	 1			Applicazione secondo necessità.
	 2	6		Non ingrassare i fori.
	 3	6		Ingrassare questa zona.
	 4			Verso di montaggio
	 5	10		Posizionare il foro in direzione della posizione 14.
	 6	13		Osservare la posizione di montaggio.
	 7	10		Osservare la posizione di montaggio.
	 8	2; 3; 7; 8; 10; 12; 13; 14		Ingrassare esclusivamente la suddetta posizione. 8305021014, Isoflex Topas L 32

pl

Hasła ostrzegawcze i symbole

-  **DANGER** NIEBEZPIECZEŃSTWO Bezpośrednie zagrożenie ciężkimi obrażeniami bądź śmiercią.
-  **WARNING** UWAGA! Niebezpieczeństwo grożące lekkimi bądź średnimi obrażeniami.
-  **CAUTION** OSTRZEŻENIE Niebezpieczeństwo grożące śmiercią bądź ciężkimi obrażeniami.
-  Części oznaczone kółkiem wokół numeru pozycji należą do zestawu naprawczego.

-  Wskazówki / Informacje dotyczące poprawnej naprawy.
-  Zestaw naprawczy może być używany do urządzeń według tabeli.
-  Dokręcić element podanym momentem obrotowym.

pl

Ogólne porady naprawcze

1. Prace naprawcze w obrębie urządzeń układu bezpieczeństwa pojazdu mogą być wykonane jedynie przez wykwalifikowany personel specjalistycznego warsztatu.
2. Należy koniecznie postępować według wytycznych i wskazówek producenta pojazdu.
3. Należy przestrzegać zakładowych i krajowych przepisów BHP.
4. Należy używać wyłącznie części zamiennych dopuszczonych przez firmę WABCO bądź przez producenta pojazdu.
5. Naprawę należy rozpocząć dopiero wówczas, gdy wszystkie informacje potrzebne do niej zostaną przeczytane i zrozumiane. Dokumenty potrzebne dodatkowo: instrukcja kontrolna, tabela części zamiennych, ogólne wskazówki dotyczące naprawy i kontroli (815 020 109 3) znajdują Państwo na stronie internetowej www.wabco-auto.com, podając numer urządzenia bądź numer publikacji w bazie INFORM.
6. Na odpowiednim urządzeniu należy sprawdzić każde naprawiane urządzenie - zgodnie z instrukcją kontrolną - pod kątem sprawności działania i szczelności.

Obraz	Symbol	Pozycja	Wartość	Wskazówka
				Podczas wszystkich prac naprawczych należy zachować jak najwyższą czystość otoczenia.
		16	2,5 + 1 Nm	
		1		Do użycia według potrzeby.
		2		Nie smarować otworów.
		3		Ten obszar smarować.
		4		Kierunek montażu
		5		Zlokalizować otwór w kierunku na pozycję 14.
		6		Zwrócić uwagę na położenie montażowe.
		7		Zwrócić uwagę na położenie montażowe.
		8	2; 3; 7; 8; 10; 12; 13; 14	Użyj smaru do zaznaczonych elementów. 8305021014, Isoflex Topas L 32

ru

Знаки & символы

- DANGER** ОПАСНО Прямая угроза аварийной ситуации: влечет за собой смерть или тяжелые повреждения
- WARNING** ОСТОРОЖНО Опасная ситуация: последствиями являются легкие повреждения или повреждения средней тяжести, а также материальный ущерб
- CAUTION** ПРЕДУПРЕЖДЕНИЕ Опасная ситуация: влечет за собой смерть или тяжелые повреждения
- Указание/информация для проведения надлежащего ремонта
- Ремкомплект может быть использован для приборов соответственно таблице.
- Затянуть элемент с заданным моментом затяжки или на заданный угол поворота.
- Номера частей, обведенные кружком, Вы найдете в ремкомплекте.

Общие указания по ремонту

1. Провождение ремонта приборов данной системы должно производиться только квалифицированным персоналом в специализированной мастерской.
2. Следуйте предписаниям и инструкциям изготовителя транспортного средства.
3. Соблюдайте предписания предприятия по технике безопасности, а также национальные нормы.
4. Используйте только запчасти, допущенные к использованию компанией Wabco или производителем транспортного средства.
5. Проводите ремонт только после того, как вы прочитали и поняли все информации, необходимые для данного процесса. Дополнительные документы: инструкция по тестированию, список запасных частей, общие инструкции по ремонту и проведению испытаний (815 080 109 3) Вы найдете на www.wabco-auto.com. Для этого необходимо задать номер нужного прибора или номер брошюры в INFORM.
6. Проконтролируйте каждый отремонтированный прибор - согласно инструкции по тестированию - на работоспособность и герметичность с помощью соответствующего оборудования.

ru

Изображение	Символ	Позиция	Значение	Указание
1				При проведении ремонтных работ соблюдайте полную чистоту.
		16	2,5 + 1 Nm	
		1		Использование по надобности.
		2	6	Не смазывайте отверстия.
		3	6	смазывайте этот участок.
		4		Направление, в котором производится монтаж
		5	10	Расположить отверстие по направлению к позиции 14.
		6	13	Обратите внимание на местоположение при монтаже.
		7	10	Обратите внимание на местоположение при монтаже.
		8	2; 3; 7; 8; 10; 12; 13; 14	Смажьте названную часть. 8305021014, Isoflex Topas L 32

tr

Semboller&belirti sözleri

- DANGER** TEHLİKE Tehlikeli durum: ciddi personel yaralanması veya ölüm riski.
- WARNING** DİKKAT Tehlike riski: hafif personel yaralanması veya maddi zarar.
- CAUTION** UYARI Ciddi personel yaralanması veya ölüm riski.
- Yuvarlak içinde numarası belirtilen parça numaraları kit içerisinde bulunur.

Talimat/ Doğru tamir için bilgi

Tabloda belirtilen parçalar için kit kullanılabilir.

Elemanı belirtilen sıkma torku ya da dönme açısı ile sıkın.





Genel tamir bilgisi



- Araçların güvenlik sistemlerinde tamir işlemlerini yalnızca eğitim almış konusunda uzman personeller gerçekleştirebilir.
- Şirket emniyet kuralları ve ulusal regülasyonlarına uyunuz.
- Tamire, tamir işlemi için gerekli olan tüm bilgileri okuyup anladıktan sonra başlayınız. Ayrıca gerekli olan dokümanlar: Test talimatı, yedek parça sayfası, genel tamir ve test bilgileri (815 140 109 3). Tümünü linki altında, online ürün kataloğu INFORM'da cihaza ait ürün numarasını veya baskı numarasını girerek bulabilirsiniz.
- Araç üretici firma özellikler ve talimatlarına kesinlikle uyunuz.
- Sadece WABCO veya üretici firma tarafından yayınlanan yedek parçaları kullanın.
- Tamir edilmiş her cihazı - test talimatına uygun şekilde - uygun bir donanımla işlevsellik ve sızdırmazlık konusunda kontrol edin.

Resim	Sembol	Parça	Değer	İp ucu
1				Tamirat esnasında etrafın çok temiz olmasına dikkat edin.
		16	2,5 + 1 Nm	
		1		İhtiyaç olması halinde kullanılmalıdır.
		2	6	Delikleri greslemeyin ve yağlamayın.
		3	6	Bu bölgeyi gresleyin
		4		Montaj yönü
		5	10	Deligi, pozisyon 14 üzerine gelecek yönünde konumlandırın.
		6	13	Montaj konumuna dikkat.
		7	10	Montaj konumuna dikkat.
		8	2; 3; 7; 8; 10; 12; 13; 14	Yalnızca belirtilen pozisyonu gresleyin. 8305021014, Isoflex Topas L 32

pt











Símbolos e Significados

-  **DANGER** Perigo! Risco de acidente iminente: lesão corporal grave e/ou risco de morte.
-  **WARNING** Cuidado! Possível situação de acidente: ferimentos leves/moderados e/ou danos materiais.
-  **CAUTION** Atenção! Possível situação de acidente: lesão corporal grave e/ou risco de morte.
-  Componentes que estão marcados com um círculo compõem o jogo de reparo.

-  Instrução/Informação para uma correta reparação.
-  O jogo de reparo pode ser utilizado nos produtos relacionados na tabela.
-  Apertar o elemento com o binário ou o ângulo de rotação indicado.





Dicas Gerais para Reparação



1. Por motivo de segurança, somente pessoas qualificadas devem efetuar reparação nos sistemas de freio do veículo.
3. Mantenha e siga as orientações de prevenção de acidentes vigentes e/ou impostas pelos órgãos competentes.
5. Somente inicie o trabalho de reparação após ler e entender todas as informações necessárias para realizar uma reparação. Documentos adicionais necessários: instrução de teste, lista de peças sobressalentes, dicas gerais de testes e reparação (815 130 109 3) podem ser encontrados no site www.wabco-auto.com ao inserir o número do produto.
2. Siga sempre as recomendações/especificações do fabricante do veículo.
4. Use somente peças de reposição aprovadas pela WABCO ou pelo fabricante do veículo.
6. Verificar cada produto reparado conforme instruções de teste, utilizando os equipamentos necessários e local adequado.

Figura	Símbolo	Item	Valor	Sugestão
1				Durante a reparação mantenha o local de trabalho sempre limpo.
		16	2,5 + 1 Nm	
		1		Para ser utilizado somente quando necessário
		2	6	Não lubrificar os orifícios.
		3	6	Lubrificar estas zonas
		4		Sequência de montagem
		5	10	Posicione os orifícios na direção na posição 14.
		6	13	Observar a posição de montagem
		7	10	Observar a posição de montagem
		8	2; 3; 7; 8; 10; 12; 13; 14	Aplicar graxa no item 8305021014, Isoflex Topas L 32

ro

Simboluri și cuvinte pentru avertizare

-  **DANGER** Situație de pericol iminentă: poate rezulta vătămare corporală gravă sau deces.
-  **WARNING** Posibilă situație de pericol: pot rezulta vătămări corporale minore sau medii sau pagube materiale
-  **CAUTION** Posibilă situație de pericol: poate rezulta vătămare corporală gravă sau deces
-  Pieșele cu numărul de articol încercuit sunt incluse în kit.

-  Instrucțiuni / Informare pentru o reparare corectă
-  Kitul poate fi folosit pentru dispozitive, conform tabelului.
-  Strângeți elementul cu cuplul, respectiv unghiul de rotire indicat.

ro

Instrucțiuni generale referitoare la reparație

1. Numai personalul calificat al unui atelier de service specializat este autorizat să efectueze lucrări de reparații pe sistemul de siguranță al vehiculului.
2. Respectați obligatoriu instrucțiunile date de producătorul vehiculului.
3. Respectați prevederile firmei și cele naționale pentru prevenirea accidentelor.
4. Utilizați exclusiv piese de schimb autorizate de WABCO sau de producătorul autovehiculului.
5. Întotdeauna începeți lucrările de reparații numai după ce ați citit și înțeles toate informațiile necesare pentru reparație. Documente suplimentare necesare: Instrucțiuni de testare, Lista pieselor de schimb, Instrucțiuni generale pentru reparare și testare (815 110 109 3) pot fi găsite pe www.wabco-auto.com introducând codul dispozitivului în INFORM.
6. Verifică eficiența funcțională și etanșeitatea fiecărui echipament reparat pe o instalație adecvată în conformitate cu instrucțiunile de testare.

Imagine	Simbol	Articol	Valoare	Instrucțiune
				Pe durata reparației asigurați-vă ca spațiul din jur este foarte curat.
		16	2,5 + 1 Nm	
		1		Va fi folosit la nevoie când situația o cere.
		2	6	Nu gresați orificiile.
		3	6	Gresați această zonă.
		4		Direcția de asamblare
		5	10	Poziționați orificiul în direcția poziției 14.
		6	13	Observați poziția de instalare.
		7	10	Observați poziția de instalare.
		2; 3; 7; 8; 10; 12; 13; 14		Gresați componentele indicate. 8305021014, Isoflex Topas L 32

ko











Symbols & Signal Words

- DANGER** 급박한 위험 상황: 심각한 상해 또는 사망에 이르게 할 수 있습니다.
- WARNING** 잠재적 위험 상황: 경미하거나 완화된 부상 또는 물질적 손실을 입을 수 있습니다.
- CAUTION** 잠재적 위험 상황: 심각한 상해 또는 사망에 이르게 할 수 있습니다.
- 본 키트에는 원숫자로 표기된 제품들만 포함되어 있습니다.

- 올바른 수리를 위한 설명 / 정보
- 표를 참조하여 제품에 대한 키트를 사용할 수 있습니다.
- 제시된 토크 및 회전각으로 요소를 조이십시오.

1. 자격이 있는 전문 정비사만이 차량의 안전 시스템을 수리하실 수 있습니다.
2. 꼭 차량제조사의 사양과 지침서를 따르십시오.
3. 회사의 사고예방 규제와 국내 법적 규제를 지키십시오.
4. 와브코 또는 차량 제조사로부터 제공된 예비부품만을 사용하십시오.
5. 항상 수리에 필요한 모든 정보를 읽고 이해했을 때만 작업을 시작하십시오. 추가적으로 필요한 간행물: 검사지침, 예비부품 리스트, 일반적인 수리 및 검사 참고사항 (815 010 109 3)은 와브코 홈페이지 www.wabco-auto.com의 INFORM으로 들어가셔서 제품번호 또는 간행물 번호를 조회하여 찾으실 수 있습니다.
6. 기능적 효율과 견고함을 위해 검사지침에 따라 각 수리장비들을 적절한 설비위에서 체크해 보시기 바랍니다.

ko

그림	기호	품목	값	참고사항
1				수리작업 동안 오염되지 않도록 주변환경을 매우 청결히 유지해 주십시오.
		16	2,5 + 1 Nm	
	 1			경우에 따라 필요한 만큼 사용.
	 2	6		구멍에 구리스가 없도록 하십시오.
	 3	6		이 부위에 구리스를 도포하십시오.
	 4			조립 방향
	 5	10		14번 품목 방향으로 구멍을 조정하십시오.
	 6	13		장착 위치를 준수 하십시오.
	 7	10		장착 위치를 준수 하십시오.
	 8	2; 3; 7; 8; 10; 12; 13; 14		명시된 품목에 구리스를 도포하십시오. 8305021014, Isoflex Topas L 32